

ba52300e **Handheld meter
Cond 315i**

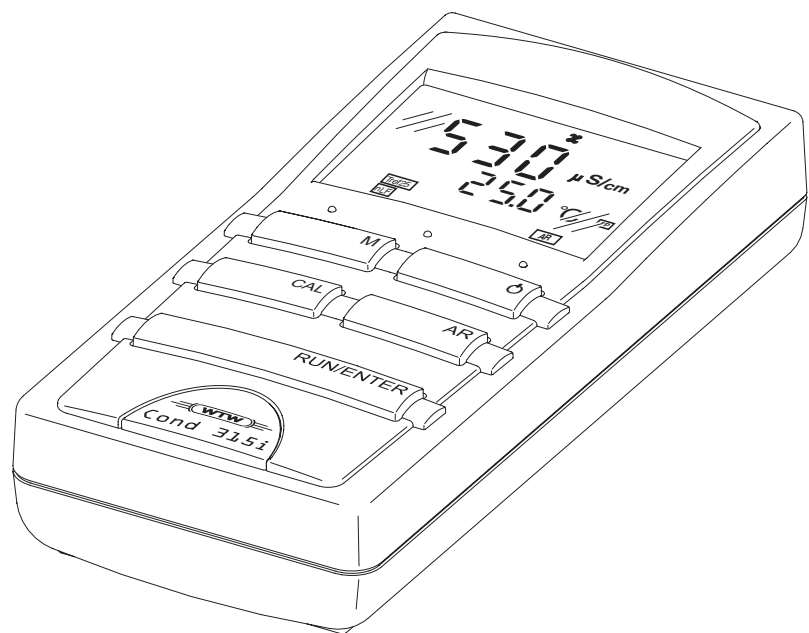

Conductivity measuring instrument

**Accuracy when
going to press**

The use of advanced technology and the high quality standard of our instruments are the result of continuous development. This may result in differences between this operating manual and your instrument. Also, we cannot guarantee that there are absolutely no errors in this manual. Therefore, we are sure you will understand that we cannot accept any legal claims resulting from the data, figures or descriptions.

Warranty

We guarantee the instrument described for 3 years from the date of purchase.

The instrument warranty covers manufacturing faults that are discovered within the warranty period. The warranty does not cover components that are replaced during maintenance work, e.g. batteries.

The warranty claim extends to restoring the instrument to readiness for use but not, however, to any further claim for damages. Improper handling or unauthorized opening of the instrument invalidates any warranty claim.

To ascertain the warranty liability, return the instrument and proof of purchase together with the date of purchase freight paid or prepaid.

Copyright

© Weilheim 2002, WTW GmbH & Co. KG

Reproduction in whole - or even in part - is prohibited without the express written permission of WTW GmbH, Weilheim & Co. KG.

Printed in Germany.

Contents

- 1 Overview 5**
 - 1.1 SETs of equipment 6
 - 1.2 Keypad 7
 - 1.3 Display 8
 - 1.4 Jack field 8

- 2 Safety 9**
 - 2.1 Authorized use 9
 - 2.2 General safety instructions 10

- 3 Commissioning 11**

- 4 Operation 13**
 - 4.1 Switching on the measuring instrument 13
 - 4.2 Measuring 13
 - 4.2.1 General information 13
 - 4.2.2 Conductivity / Specific resistance 14
 - 4.2.3 Salinity 15
 - 4.3 Cell constant / Temperature compensation 17
 - 4.3.1 Setting the cell constant C 17
 - 4.3.2 Switching the temperature compensation (TC) on/off 18
 - 4.4 Configuration 21
 - 4.5 Reset 23

- 5 Maintenance, cleaning, disposal 25**
 - 5.1 Maintenance 25
 - 5.2 Cleaning 26
 - 5.3 Disposal 26

- 6 What to do if... 27**

- 7 Technical data 29**

- 8 Lists 31**

1 Overview

The compact precision Cond 315i handheld meter enables you to carry out conductivity measurements rapidly and reliably.

The Cond 315i handheld meter provides the maximum degree of operating comfort, reliability and measuring certainty for all applications.

The proven procedure for adjusting the cell constant and the special AutoRead function support you in your work with the conductivity measuring instrument.

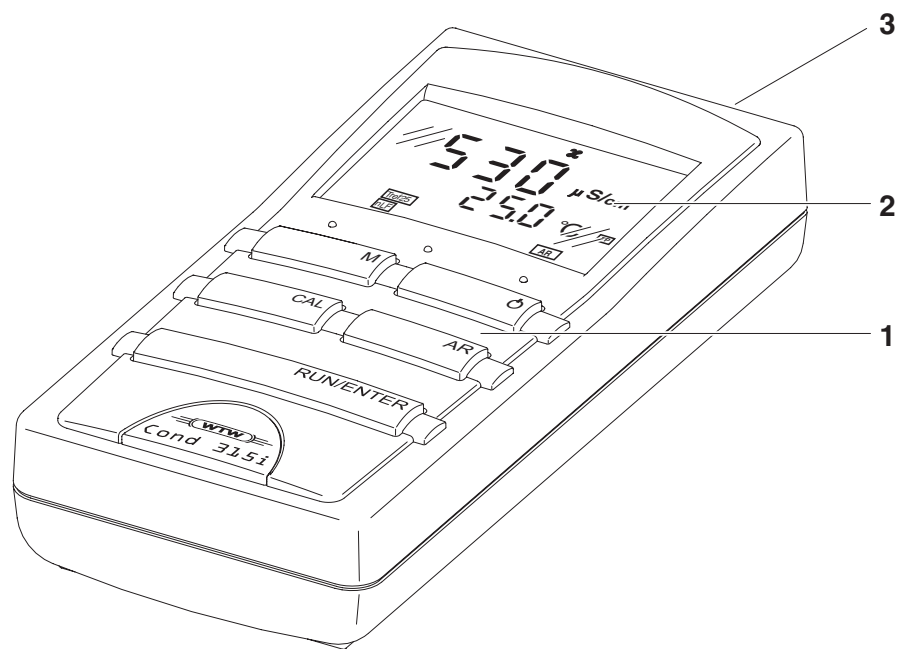

1	Keypad
2	Display
3	Jack field



Note

If you need further information or application notes, you can obtain the following material from WTW:

- Application reports
- Primers
- Safety datasheets.

You will find information on available literature in the WTW catalog or via the Internet.

1.1 SETs of equipment

The measuring instrument is also available as part of individual SETs of equipment.

You will find additional information on this and other accessories in the WTW catalog or via the Internet.

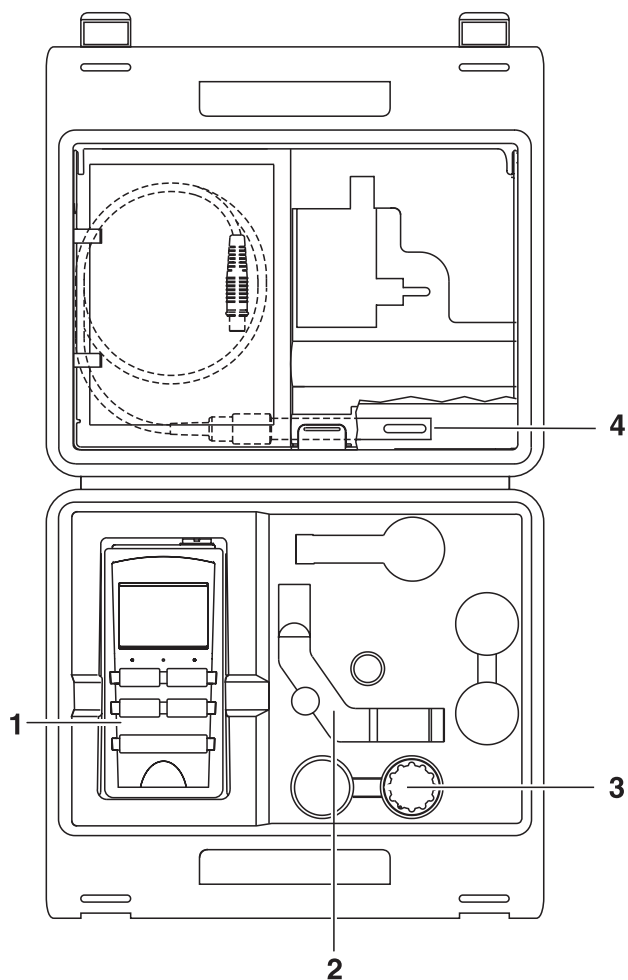



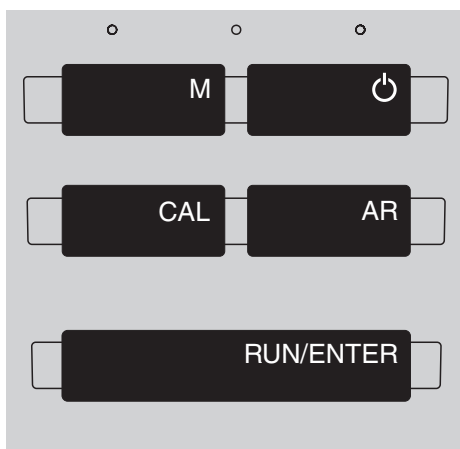

Set (sample configuration):

1	Measuring instrument, Cond 315i
2	Stand
3	– 50 ml control standard for conductivity measuring cells – Beaker, 50 ml
4	Conductivity measuring cell

1.2 Keypad



Key functions

	Select the measuring mode <M> : – Conductivity/Specific resistance – Salinity
	Switch measuring instrument on/off <ON/OFF>
	– Determine or set up the cell constant – Select temperature compensation <CAL>
	Activate/deactivate the AutoRead function <AR>
	Confirm entries, start AutoRead <RUN/ENTER>

1.3 Display

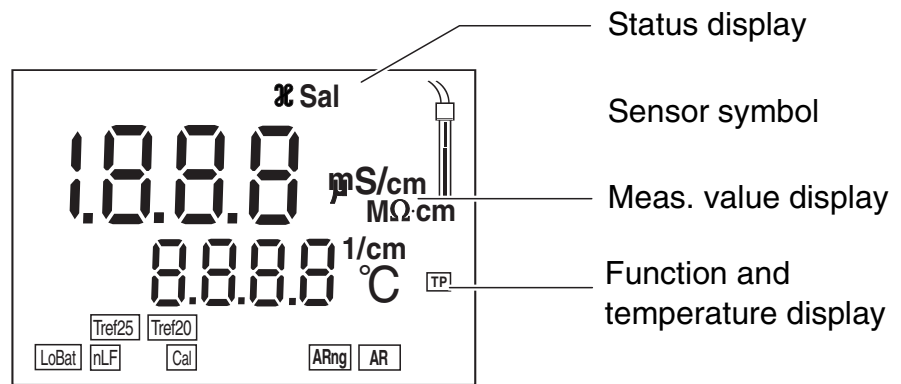

1.4 Jack field

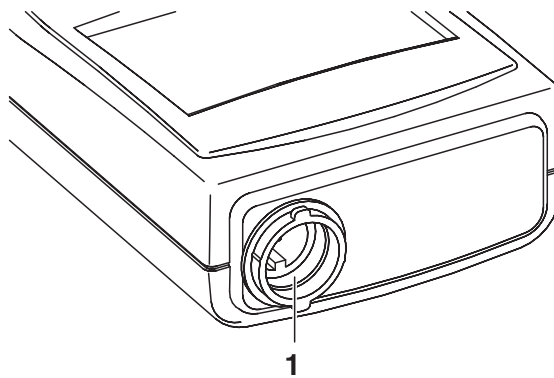

- 1 | Conductivity measuring cell

2 Safety

This operating manual contains basic instructions that you must follow during the commissioning, operation and maintenance of the measuring instrument. Consequently, all responsible personnel must read this operating manual carefully before working with the measuring system. The operating manual must always be available within the vicinity of the measuring system.

Target group

The measuring instrument was developed for work in the field and in the laboratory. We assume that, as a result of their professional training and experience, the operators will know the necessary safety precautions to take when handling chemicals.

Symbols used



Warning

indicates instructions that must be followed to prevent damage to your instrument.



Note

indicates notes that draw your attention to special features.

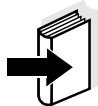

Note

indicates cross-references to other documents, e.g. application reports, operating manuals of probes, etc.

2.1 Authorized use

The authorized use of the measuring instrument consists exclusively of the measurement of the conductivity and salinity in the field and laboratory.

The technical specifications as given in chapter 7 TECHNICAL DATA must be observed. Only the operation and running of the measuring instrument according to the instructions given in this operating manual is authorized.

Any other use is considered to be **unauthorized**.

2.2 General safety instructions

This instrument is built and inspected according to the relevant guidelines and norms for electronic measuring instruments (see chapter 7 TECHNICAL DATA).

It left the factory in a safe and secure technical condition.

Function and operating safety

The smooth functioning and operational safety of the measuring instrument can only be guaranteed if the generally applicable safety measures and the specific safety instructions in this operating manual are followed during operation.

The smooth functioning and operational safety of the measuring instrument can only be guaranteed under the environmental conditions that are in specified in chapter 7 TECHNICAL DATA.

If the instrument was transported from a cold environment to a warm environment, the formation of condensate can lead to the faulty functioning of the instrument. In this event, wait until the temperature of the instrument reaches room temperature before putting the instrument back into operation.

Safe operation

If safe operation is no longer possible, the instrument must be taken out of service and secured against inadvertent operation!

Safe operation is no longer possible if the measuring instrument:

- has been damaged in transport
- has been stored under adverse conditions for a lengthy period of time
- is visibly damaged
- no longer operates as described in this manual.

If you are in any doubt, please contact the supplier of the instrument.

Obligations of the purchaser

The purchaser of the measuring instrument must ensure that the following laws and guidelines are observed when using dangerous substances:

- EEC directives for protective labor legislation
- National protective labor legislation
- Safety regulations
- Safety datasheets of the chemical manufacturers.

3 Commissioning

Scope of delivery

- Handheld meter, Cond 315i
- Operating manual and short operating manual
- 4 batteries, 1.5 V Mignon type AA (in the instrument)

For details of scope of delivery of SETs, see chapter 1.1 SETs OF EQUIPMENT and WTW catalog.

4 Operation

4.1 Switching on the measuring instrument

1	Connect a conductivity measuring cell to the measuring instrument.
2	Press the <ON/OFF> key. Display test appears briefly on the display. Subsequently, the selected cell constants and the temperature compensation that was set up appear for approx. one second one after the other. The measuring instrument then switches to the measuring mode that was last selected.

4.2 Measuring

4.2.1 General information

Preparatory activities

Perform the following preparatory activities when you want to measure:

1	Connect a conductivity measuring cell to the measuring instrument.
2	Set up the correct cell constant for the conductivity measuring cell (see section 4.3.1).
3	Use <M> to change between the conductivity measuring mode (\mathcal{X} in $\mu\text{S}/\text{cm}$) or salinity (SAL).

Temperature probe

Only carry out measurements with a temperature probe. The temperature probe is shown on the display by *TP*.

The WTW TetraCon325 conductivity measuring cell has a temperature sensor integrated in it.



Note

The conductivity measuring instrument automatically recognizes the type of the temperature probe used. This enables the measuring cells to be connected with the NTC30 or Pt1000.

Temperature compensation

The instrument has a nonlinear temperature compensation that can be switched off (see section 4.3 CELL CONSTANT / TEMPERATURE COMPENSATION).

Reference temperature, *Tref*

The reference temperature (*Tref*) can be switched between 20 °C and 25 °C. It appears on the display as *Tref20* or *Tref25*. To switch over the reference temperature, see section 4.4 CONFIGURATION.

4.2.2 Conductivity / Specific resistance

Note

You can display measured values in the units $\mu\text{S}/\text{cm}$ (conductivity) or $\text{M}\Omega\cdot\text{cm}$ (specific resistance). This basic setting is described in section 4.4 CONFIGURATION.

Thus, you can carry out conductivity measurements or measurements of the specific resistance:

1	Perform the preparatory activities according to section 4.2.1.
2	Immerse the conductivity measuring cell in the test sample.
3	Press the <M> key until \mathcal{K} appears on the status display. Depending on the basic setting in the CONFIGURATION menu, one of the following display indicators appears on the display:

Conductivity $\mu\text{S}/\text{cm}$

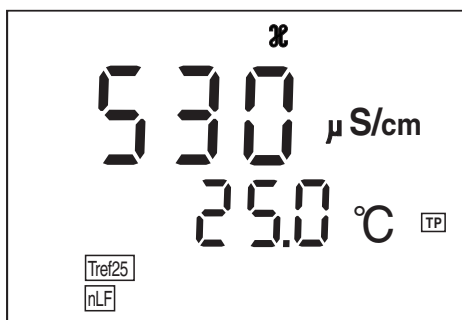

Specific resistance $\text{M}\Omega\cdot\text{cm}$

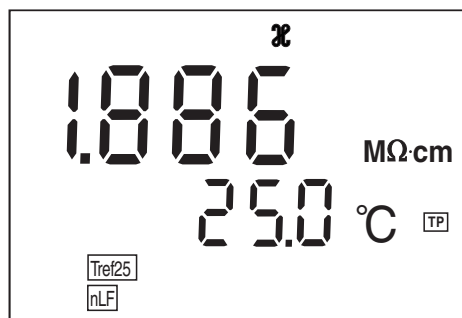

4	Wait for a stable measured value.
---	-----------------------------------

4.2.3 Salinity

You can carry out the salinity measurements as follows:

1	Perform the preparatory activities according to section 4.2.1.
2	Immerse the conductivity measuring cell in the test sample.
3	Press the <M> key until <i>Sal</i> appears on the status display. The salinity value appears on the display.

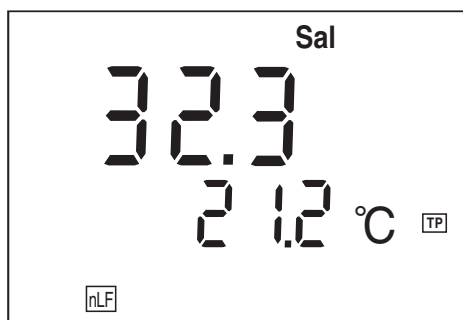

4	Wait for a stable measured value.
---	-----------------------------------

AutoRead AR (Drift control)

The AutoRead function (drift control) checks the stability of the measurement signal. The stability has a considerable effect on the reproducibility of the measured value.

1	Select the required measuring mode with <M>.
2	Activate the AutoRead function with <AR>. The current measured value is frozen (hold function).
3	Start AutoRead with <RUN/ENTER>. AR flashes until a stable measured value is reached.

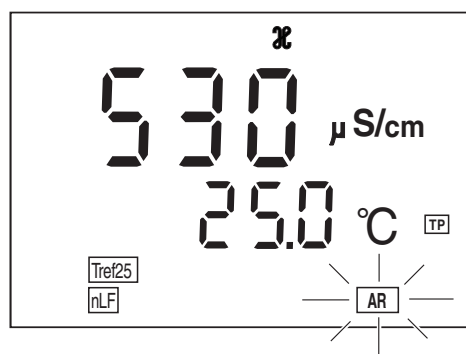

- | | |
|---|---|
| 4 | If necessary, start the next AutoRead measurement with <RUN/ENTER> . |
| 5 | To terminate AutoRead: Press the <AR> key. |

**Note**

The current AutoRead measurement can be terminated at any time (accepting the current value) by pressing **<RUN/ENTER>**.

4.3 Cell constant / Temperature compensation

You can adjust the cell constant and switch the temperature compensation on/off.

4.3.1 Setting the cell constant C

The cell constant of the conductivity measuring cell can be set to one of the following values:

- 0.475 cm⁻¹
- 0.100 cm⁻¹
- 0.875 cm⁻¹



Setting the cell constant

Note

The cell constant to be selected must either be taken from the operating manual of the measuring cell or is printed on the measuring cell.

You can select a cell constant from the fixed values 0.475 cm⁻¹, 0.1 cm⁻¹, 0.875 cm⁻¹ :

- 1 Press the <CAL> key repeatedly until the status display \mathcal{K} CELL appears.

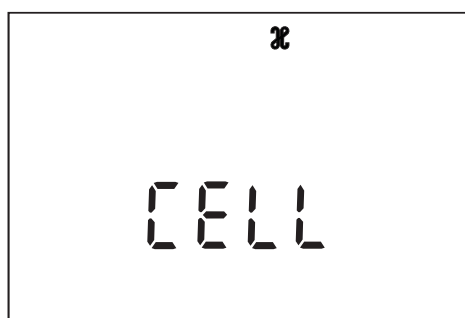

- 2 Press the <RUN/ENTER> key.

- 3 Press the <CAL> key repeatedly until the required cell constant, e.g. 0.475 cm⁻¹, appears on the display.

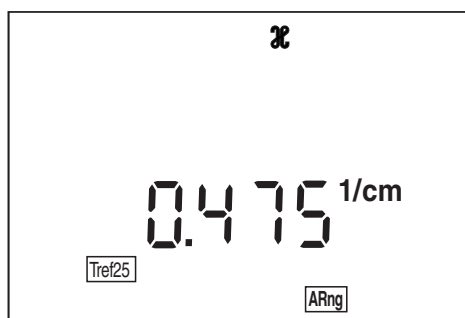

4 | To return to the measuring mode: Press the <M> key.

4.3.2 Switching the temperature compensation (TC) on/off

The basis for calculating the temperature compensation is the selected reference temperature, Tref 25 or Tref 20. For details of how to select the reference temperature, see section 4.4 CONFIGURATION.

You can select from the following settings:

- **Nonlinear temperature compensation (nLF)** according to EN 27 888
- **No temperature compensation (- - - -)**



Note

Select the temperature compensations given in the following table according to the respective test sample:

Application tips

Sample	Temperature compensation	Display indicator
Natural water (ground water, surface water and drinking water)	nLF according to DIN 38404 EN 27 888	nLF
Ultrapure water	nLF according to DIN 38404 EN 27 888	nLF
Other aqueous solutions	Measure without temperature compensation	- - - -
Salinity (seawater)	Automatic nLF according to IOT	Sal, nLF

Switching on the nonlinear temperature compensation

You can switch on the nonlinear temperature compensation as follows:

- 1 Press the **<CAL>** key repeatedly until the status display \mathcal{X} *tc* appears on the display.

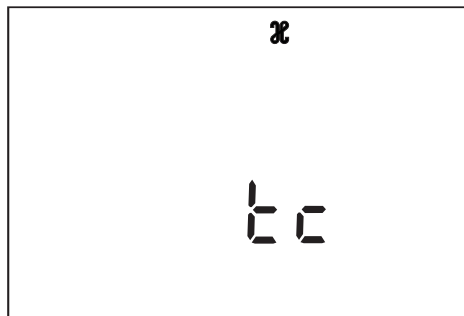

- 2 Press the **<RUN/ENTER>** key.
- 3 Press the **<CAL>** key repeatedly until *nLF* appears on the display.

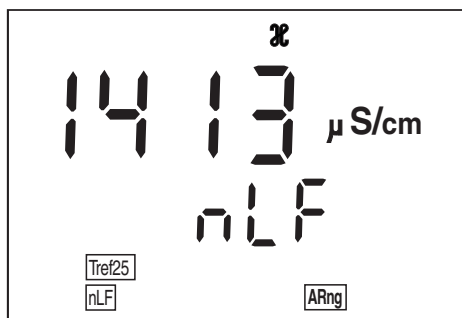

- 4 To return to the measuring mode: Press the **<M>** key.

Switching the temperature compensation off

You can switch off the temperature compensation as follows:

- 1 Press the **<CAL>** key repeatedly until *tc* appears on the display.

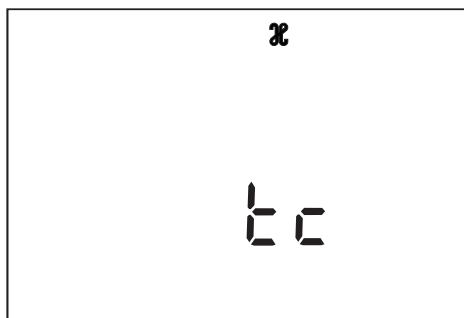

- 2 Press the **<RUN/ENTER>** key.
- 3 Press the **<CAL>** key repeatedly until 4 dashes appears on the display.

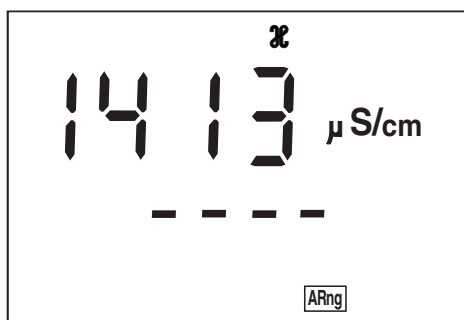

- 4 The temperature compensation is switched off.
- 5 To return to the measuring mode: Press the **<M>** key.

4.4 Configuration

You can adapt the following settings to your individual requirements (the default setting is marked in bold):

Reference temperature	25 °C (TREF25) or 20 °C (TREF20)
Display of the measured value as conductivity or specific resistance	S/cm or MΩ cm



Note

You can leave the configuration menu at any time. The parameters that have already been changed are stored. To do so, press the <M> key.

- 1 Switch off the measuring instrument.
- 2 Press the <M> key and hold it down.
- 3 Press the <ON/OFF> key. Display test appears briefly on the display. The measuring instrument then switches automatically to the setting of the reference temperature.

Selecting the reference temperature

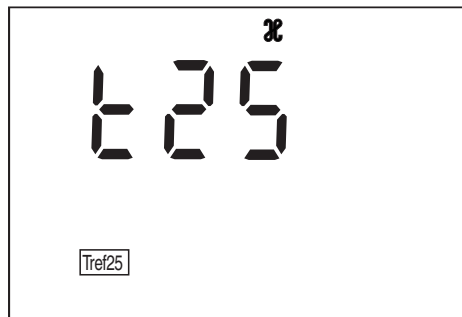

- 4 Use <CAL> to select between *t25* and *t20*.
- 5 Confirm with <RUN/ENTER>. *Cond* appears on the display.

Selecting the display of
the measured value as
conductivity / specific
resistance

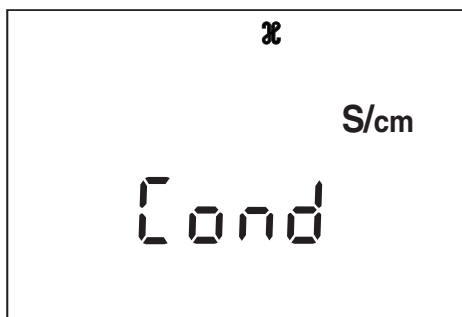

- | | |
|---|---|
| 6 | Use <CAL> to select between <i>S/cm</i> and <i>MΩ·cm</i> . |
| 7 | Confirm with <RUN/ENTER> .
The measuring instrument automatically switches to the measuring mode. |

4.5 Reset

You can reset the measuring parameters (Initialization).

Basic settings

The following settings are reset to the default values when a reset is performed (initialized):

Setting	Default settings
Measuring mode	κ
Cell constant	0.475 cm ⁻¹
Reference temperature	Tref25
Temperature compensation	nLF switched on

Proceed as follows:

- 1 Press the <RUN/ENTER> key and hold it down.
- 2 Press the <CAL> key.

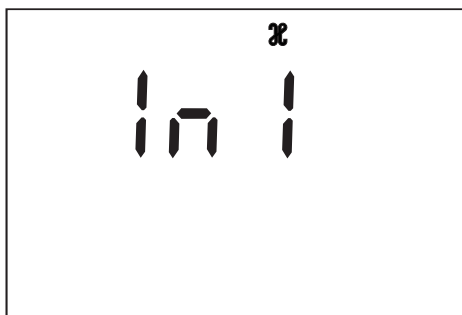

- 3 Confirm with <RUN/ENTER>. The functions are reset. The instrument switches to the measuring mode.
Retaining settings:
Use <M> to change to the measuring mode without a reset.

5 Maintenance, cleaning, disposal

5.1 Maintenance

The measuring instrument is almost maintenance-free. The only maintenance task is replacing the batteries. *LoBat* indicates that the batteries should be changed. The batteries are then largely depleted.

Replacing the batteries

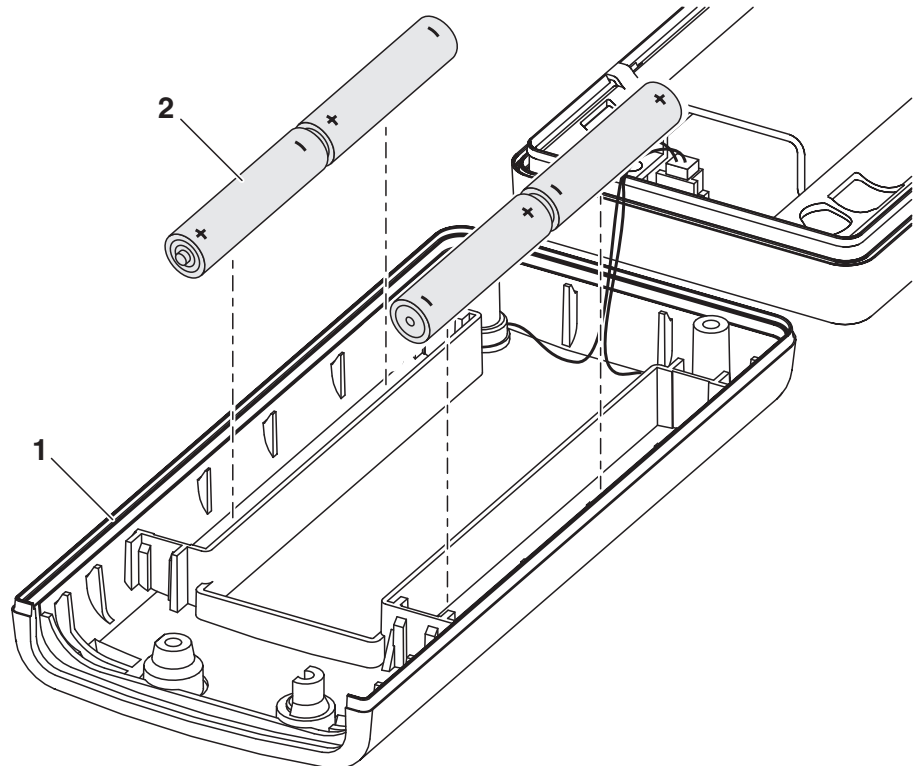

1	Open the housing after the instrument has been switched off: – Undo the four screws on the underside of the instrument – Pull down the lower cover (1).
2	If necessary, take the four depleted batteries (2) out of the battery compartment.
3	Place four new batteries (type Mignon AA) in the battery compartment.
4	Close the lower cover (1).



Warning

Make sure that the poles of the batteries are the right way round. The \pm signs on the batteries must correspond to the \pm signs in the battery compartment.
Only use leakproof alkaline manganese batteries.

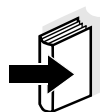
**Note**

For the maintenance of the measuring cells, follow the corresponding operating manual.

5.2 Cleaning

Occasionally wipe the outside of the measuring instrument with a damp, lint-free cloth. Disinfect the housing with isopropanol as required.

**Warning**

The housing is made of a synthetic material (ABS). Thus, avoid contact with acetone and similar detergents that contain solvents. Remove any splashes immediately.

5.3 Disposal**Packing**

This measuring instrument is sent out in a protective transport packing. We recommend: Keep the packing material. The original packing protects the instrument against damage during transport.

Batteries

This note refers to the battery regulation that applies in the Federal Republic of Germany. We would ask end-consumers in other countries to follow their local statutory provisions.

**Note**

This instrument contains batteries. Batteries that have been removed must only be disposed of at the recycling facility set up for this purpose or via the retail outlet.

It is illegal to dispose of them in household refuse.

Measuring instrument

Dispose of the measuring instrument as electronic waste at an appropriate collection point. It is illegal to dispose of the instrument in household refuse.

6 What to do if...

Display LoBat	Cause	Remedy
	<ul style="list-style-type: none"> – Batteries almost empty 	<ul style="list-style-type: none"> – Replace batteries (see section 5.1 MAINTENANCE)
Error message OFL	Cause	Remedy
	The measured value lies outside the measuring range	
	<ul style="list-style-type: none"> – Cable broken 	<ul style="list-style-type: none"> – Replace measuring cell
Instrument does not react to keystroke	Cause	Remedy
	<ul style="list-style-type: none"> – Operating condition undefined or EMC load unallowed 	<ul style="list-style-type: none"> – Press the <CAL> and <ON/OFF> keys at the same time and release them again. The software version is displayed briefly.

7 Technical data

Ambient temperature

Storage	- 25 °C ... + 65 °C
Operation	-10 °C ... + 55 °C
Allowable relative humidity	Yearly mean: < 75 % 30 days/year: 95 % Other days: 85 %

Measuring ranges and resolution of LF

κ [$\mu\text{S}/\text{cm}$]	0.000 ... 19.99 (only for cell constant = 0.1 cm^{-1}) 0.0 ... 199.9 0 ... 1999
κ [mS/cm]	0.00 ... 19.99 0.0 ... 199.9 0 ... 500
Spec. resistance [$\text{M}\Omega \cdot \text{cm}$]	0.00 ... 19.99 0.0 ... 199.9 0 ... 1999
SAL	0.0 ... 70.0 according to the IOT table
T [$^{\circ}\text{C}$]	- 5.0 ... + 105.0

Accuracy (± 1 digit)

κ	No compensation: Accuracy $\pm 0.5\%$ Nonlinear compensation $\boxed{\text{nLF}}$ Accuracy Sample temperature $\pm 0.5\%$ 0 °C ... 35 °C according to EN 27 888; $\pm 0.5\%$ 35 °C ... 50 °C extended nLF function acc. to WTW measurements
SAL	Range 0.0 ... 42.0 Accuracy Sample temperature ± 0.1 5 °C ... 25 °C ± 0.2 25 °C ... 30 °C

	T [°C]	NTC 30: Accuracy ± 0.1 PT 1000: Accuracy Operating temperature ± 0.5 0 °C ... 15 °C ± 0.1 15 °C ... 35 °C ± 1 35 °C ... 55 °C
Selecting the cell constant:	C [cm ⁻¹]	0.1 fixed 0.475 fixed 0.875 fixed
Reference temperature	TREF [°C]	25 or 20
Dimensions and weight	Length [mm]	172
	Width [mm]	80
	Height [mm]	37
	Weight [kg]	Approx. 0.3
Power supply	Batteries	4 x 1.5 V alkali-manganese batteries, Type AA
	Operational life	Approx. 3000 operating hours
Mechanical structure	Type of protection	IP 66
Guidelines and norms used	EMC	EG guideline 89/336/EWG EN 61326 -1:1997 EN 61000-3-2 A14:2000 EN 61000-3-3:1995; FCC Class A
	Instrument safety	EG guideline 73/23/EWG EN 61010-1 A2:1995
	Climatic class	VDI/VDE 3540
	Type of protection	EN 60529:1991
Test certificates	GS, cETLus, CE	

8 Lists

This chapter provides additional information and orientation aids.

Abbreviations

The list of abbreviations explains the indicators and the abbreviations that appear on the display and in the manual.

Specialist terms

The glossary briefly explains the meaning of the specialist terms. However, terms that should already be familiar to the target group are not described here.

Index

The index will help you to find the topics that you are looking for.

Abbreviations

κ	Conductivity value (international γ)
AR	AutoRead (drift control)
ARng	Automatic range switching Measuring instrument measures with highest resolution
C	Cell constant [cm^{-1}] (internat. k)
$^{\circ}\text{C}$	Temperature unit, degrees Celsius
Cal	Calibration
LoBat	Batteries almost empty (Low Battery)
nLF	Nonlinear temperature compensation
OFL	Display range exceeded (Overflow)
SELV	Safety Extra Low Voltage
TC	Temperature coefficient (internat. α)
TP	Temperature measurement active (Temperature Probe)
$T_{\text{Ref } 20/\text{T}20}$	Reference temperature of 20 $^{\circ}\text{C}$
$T_{\text{Ref } 25/\text{T}25}$	Reference temperature of 25 $^{\circ}\text{C}$

Glossary

Adjusting	To manipulate a measuring system so that the relevant value (e. g. the displayed value) differs as little as possible from the correct value or a value that is regarded as correct, or that the difference remains within the tolerance.
AutoRange	Name of the automatic selection of the measuring range.
AutoRead	WTW name for a function to check the stability of the measured value.
Calibration	Comparing the value from a measuring system (e. g. the displayed value) to the correct value or a value that is regarded as correct. Often, this expression is also used when the measuring system is adjusted at the same time (see adjusting).
Cell constant, k	Characteristic quantity of a conductivity measuring cell, depending on the geometry.
Conductivity	Short form of the expression, specific electrical conductivity. It is a measured value of the ability of a substance to conduct an electric current. In water analysis, the electrical conductivity is a dimension for the ionized substances in a solution.
Measured parameter	The measured parameter is the physical dimension determined by measuring, e. g. pH, conductivity or D. O. concentration.
Measured value	The measured value is the special value of a measured parameter to be determined. It is given as a combination of the numerical value and unit (e. g. 3 m; 0.5 s; 5.2 A; 373.15 K).
Measuring system	The measuring system comprises all the devices used for measuring, e. g. measuring instrument and probe. In addition, there is the cable and possibly an amplifier, terminal strip and armature.
Reference temperature	Fixed temperature value to compare temperature-dependent measured values. For conductivity measurements, the measured value is converted to a conductivity value at a reference temperature of 20 °C or 25 °C.
Reset	Restoring the original condition of all settings of a measuring system.
Resistance	Short name for the specific electrolytic resistance. It corresponds to the reciprocal value of the electrical conductivity.
Resolution	Smallest difference between two measured values that can be displayed by a measuring instrument.
Salinity	The absolute salinity S_A of seawater corresponds to the relationship of the mass of dissolved salts to the mass of the solution (in g/Kg). In practice, this dimension cannot be measured directly. Therefore, the practical salinity is used for oceanographic monitoring. It is determined by measuring the electrical conductivity.

Salt content	General designation for the quantity of salt dissolved in water.
Sample	Designation of the sample ready to be measured. Normally, a test sample is made by processing the original sample. The test sample and original sample are identical if the test sample was not processed.
Setting the temperature compensation	Name of a function that considers the temperature influence on the measurement and converts it accordingly. Depending on the measured parameter to be determined, the temperature compensation functions in different ways. For conductimetric measurements, the measured value is converted to a defined reference temperature. For potentiometric measurements, the slope value is adjusted to the temperature of the test sample but the measured value is not converted.
Slope	The slope of a linear calibration function.
Standard solution	The standard solution is a solution where the measured value is known by definition. It is used to calibrate a measuring system.
Temperature function	Name of a mathematical function expressing the temperature behavior of a test sample, a probe or part of a probe.

Index**A**

Authorized use 9
AutoRead 15

B

Basic settings 23

C

Calibration 17
Cell constant
 Setting 17
Conductivity 14

D

Default settings 23
Display 8
Drift control 15

E

Error messages 27

I

Initialization 23

J

Jack field 8

K

Keys 7

L

LoBat 27

M

Measuring 13

O

Operating safety 10

R

Reference temperature
(conductivity) 13

Replacing the batteries 25
Reset 23
Resetting parameters 23

S

Safety 9
safety precautions 9
Salinity 15
Scope of delivery 11
software 27

T

Temperature compensation
18
Temperature compensation
(conductivity) 13
Temperature probe
 Conductivity 13

